

V554 OUTLINE

The center of gravity: It is within 10mm from active center.

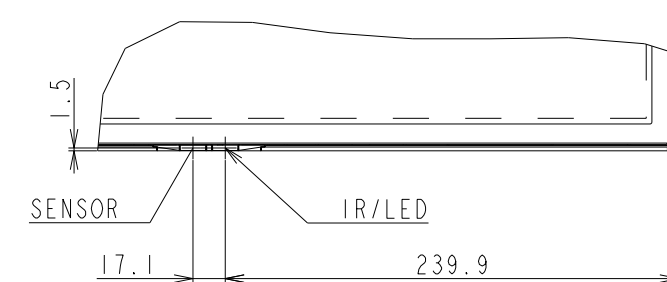
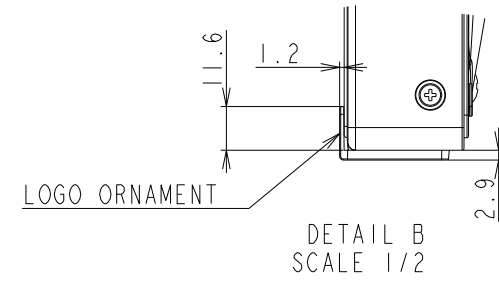
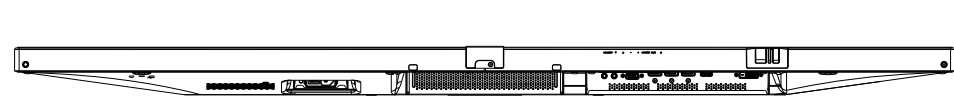
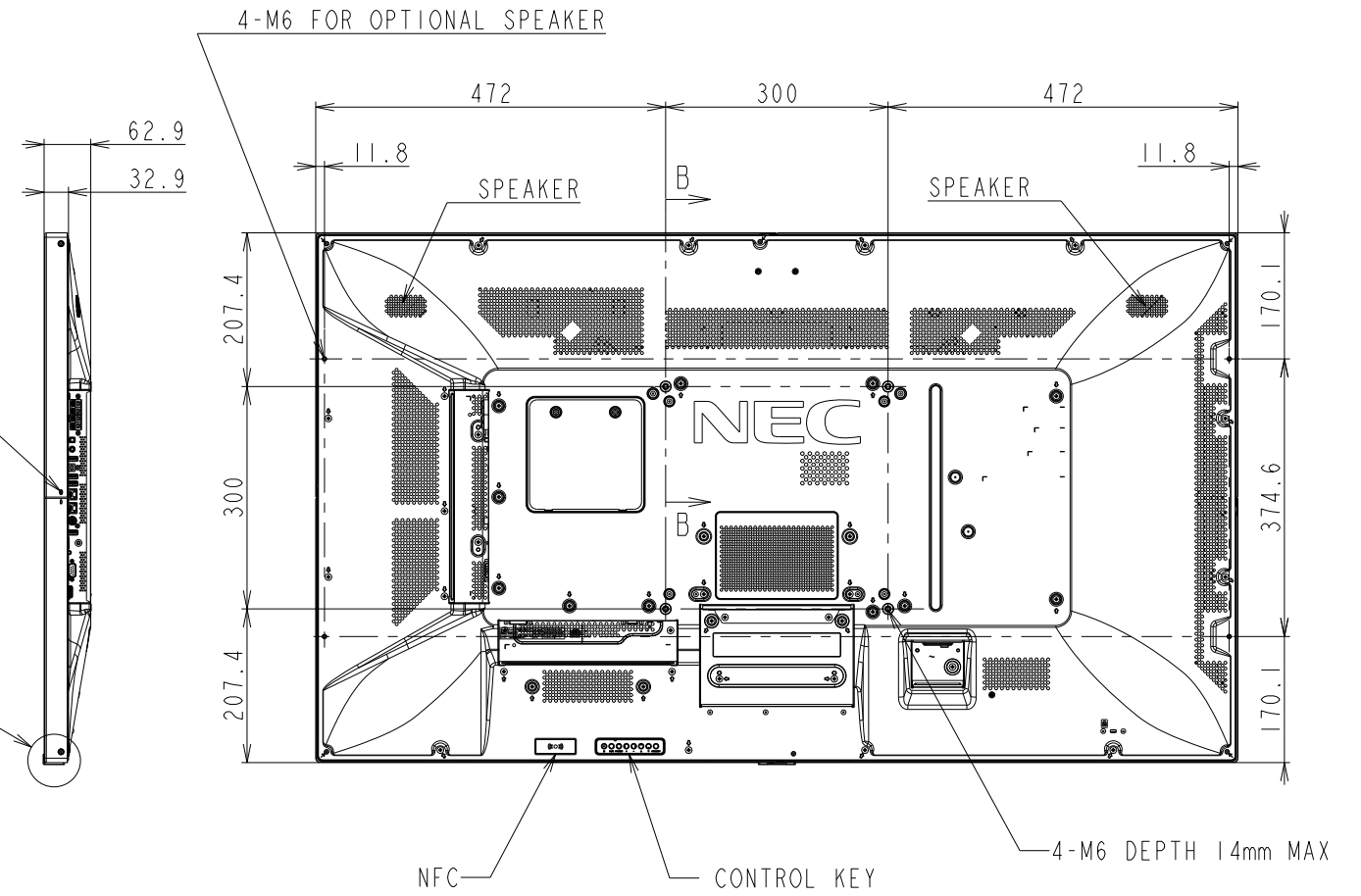
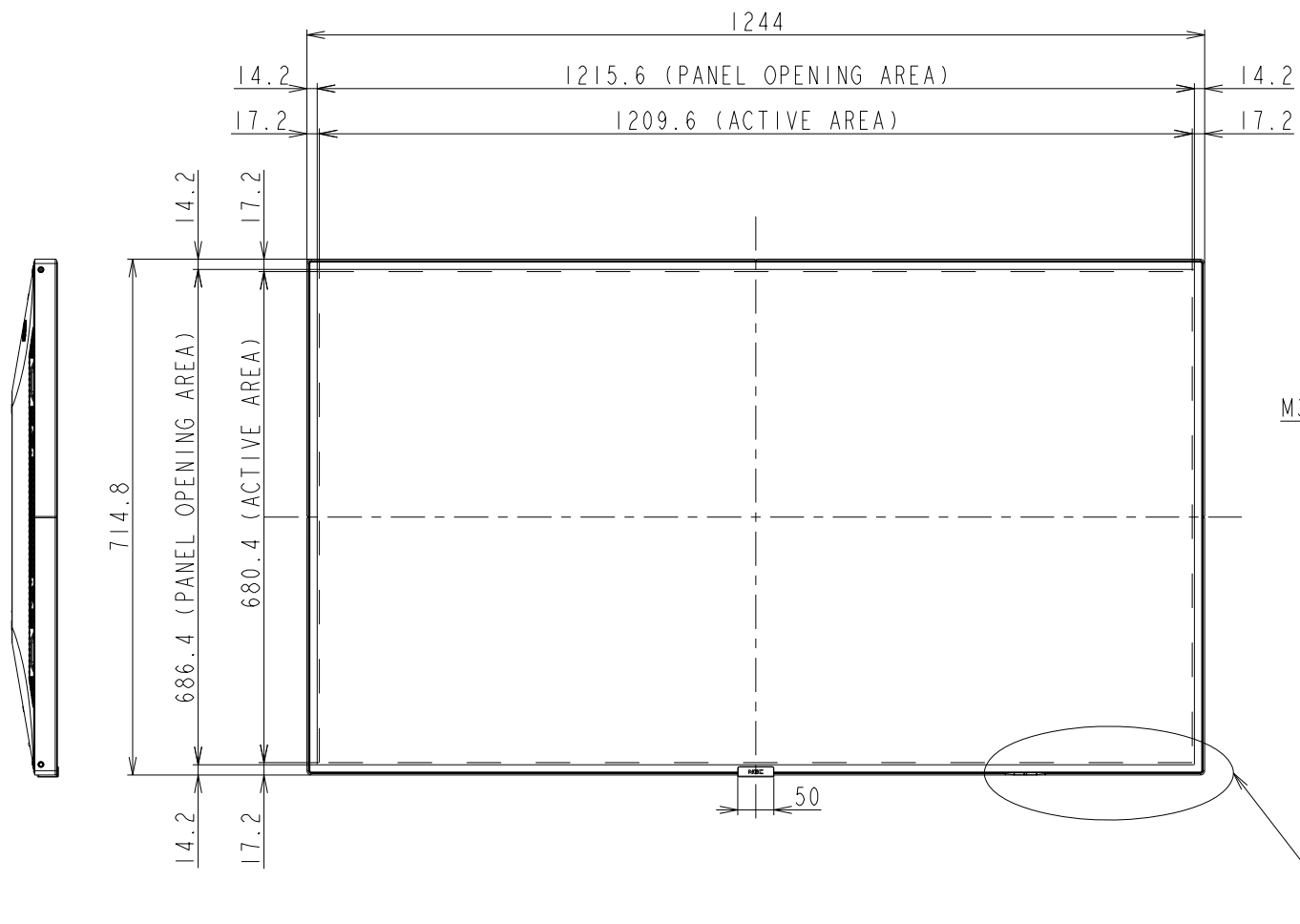
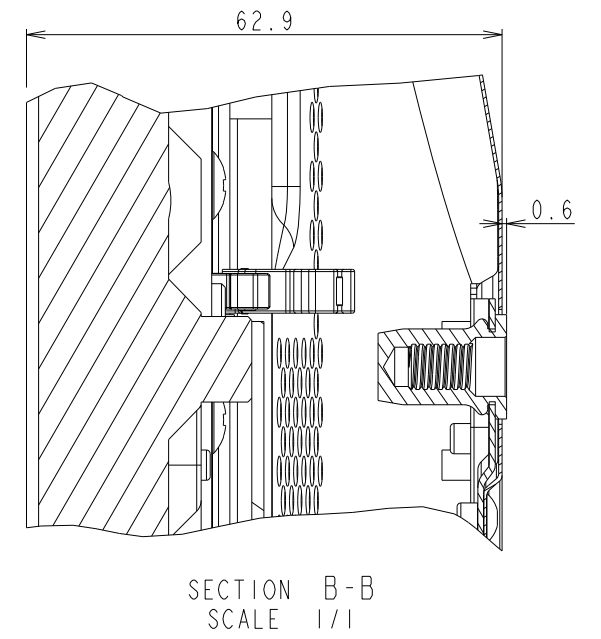
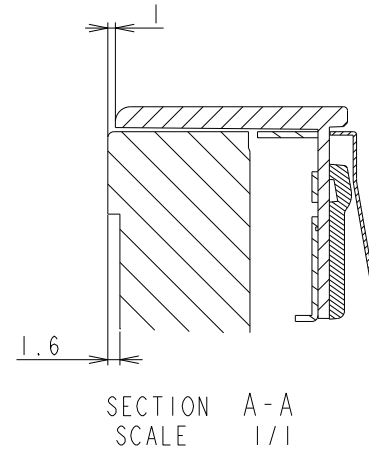
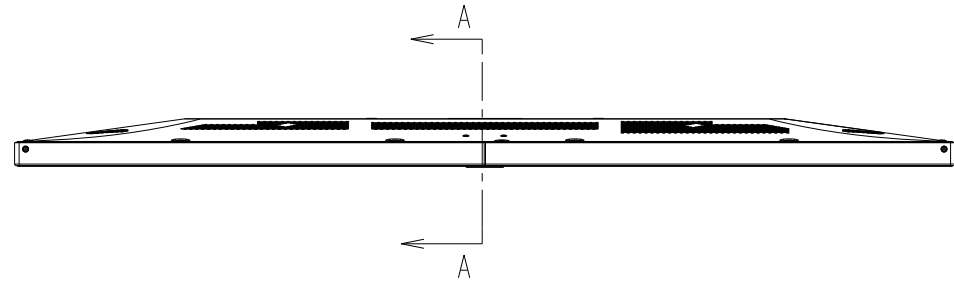

UNIT	mm
MODEL	V554
SCALE	1/10
NEC Display Solutions 2017/01/18	